

SL No	SECTION No	A	B	WEIGHT kg/m
1	S4833	17.00	4.15	0.190
2	S4826	24.00	4.00	0.259
3	10518	76.20	63.50	13.064
4	10517	150.00	50.00	20.250
5	10514	200.00	40.00	21.600

FLAT BAR

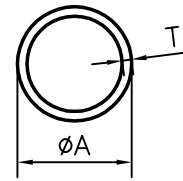

SL No	SECTION No	ØA	T	WEIGHT kg/m
1	13643	18.50	1.00	0.148
2	S4831	28.00	5.35	1.028

ROUND TUBE

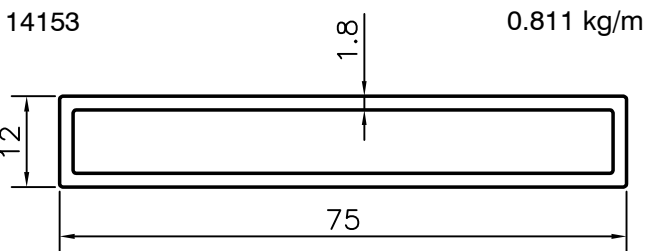

RECTANGULAR TUBE

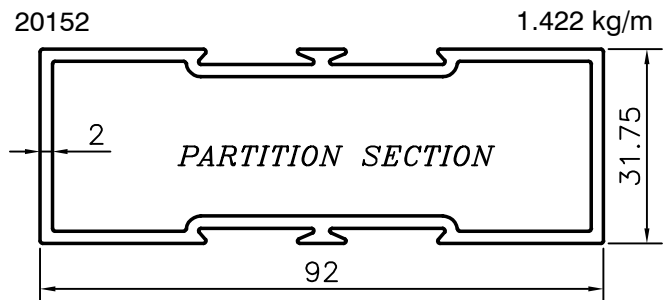

PARTITION SECTION

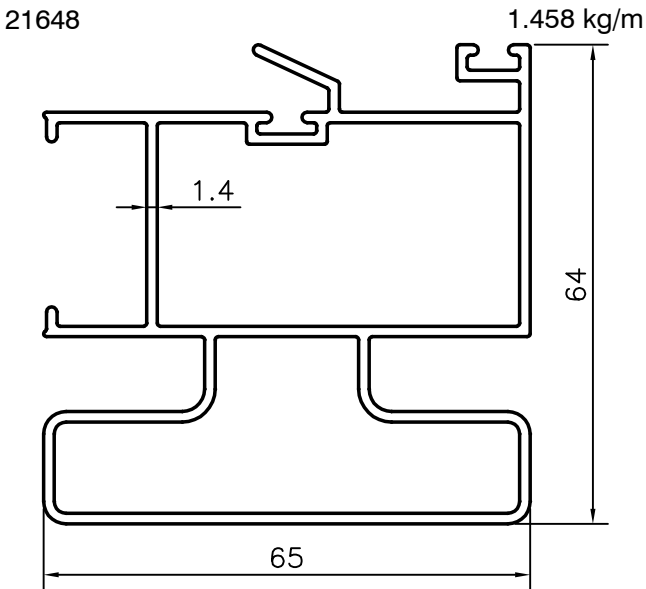

WINDOW SECTION

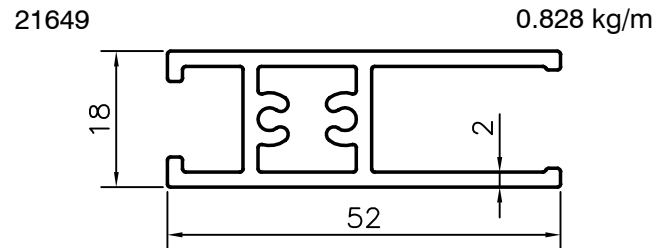

WINDOW SECTION

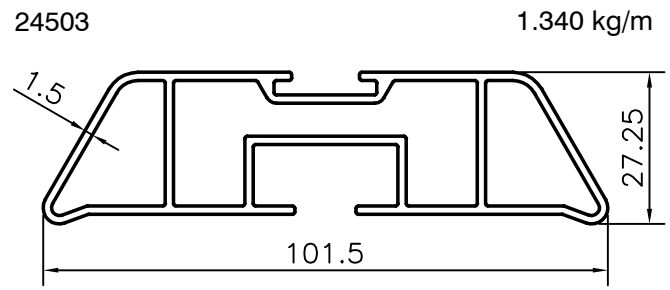

TRANSPORT SECTION

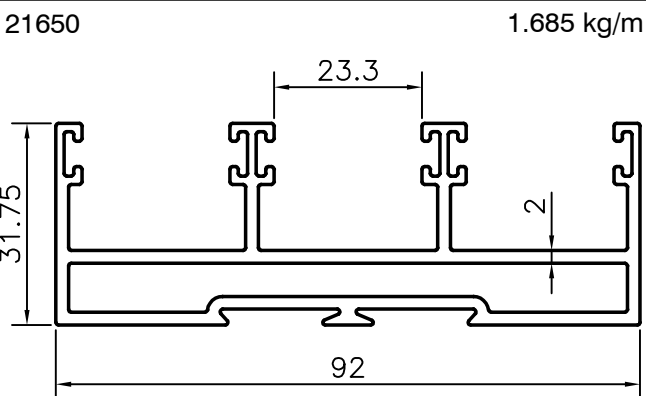

WINDOW SECTION

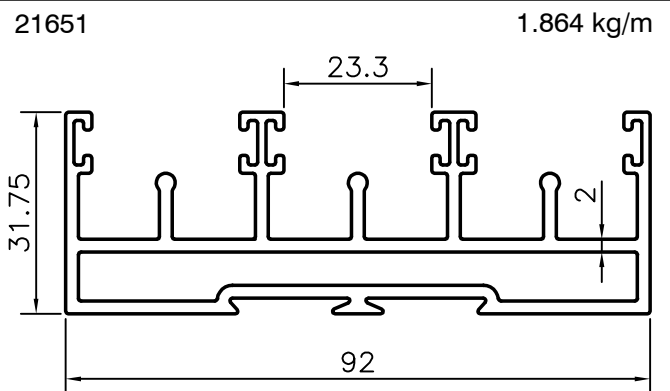

WINDOW SECTION

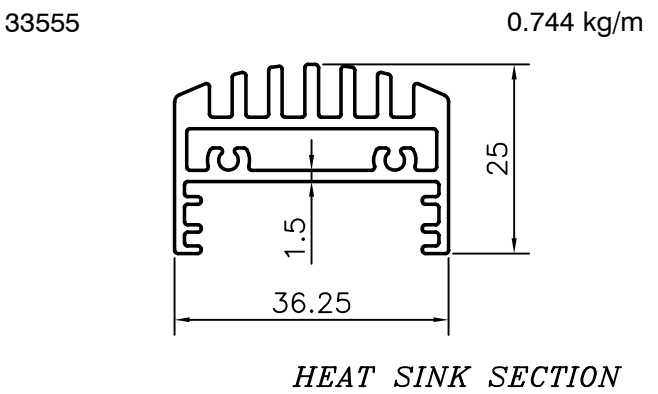
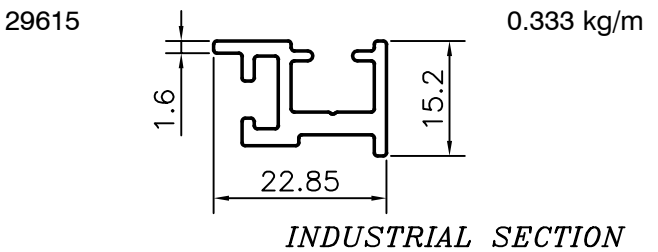
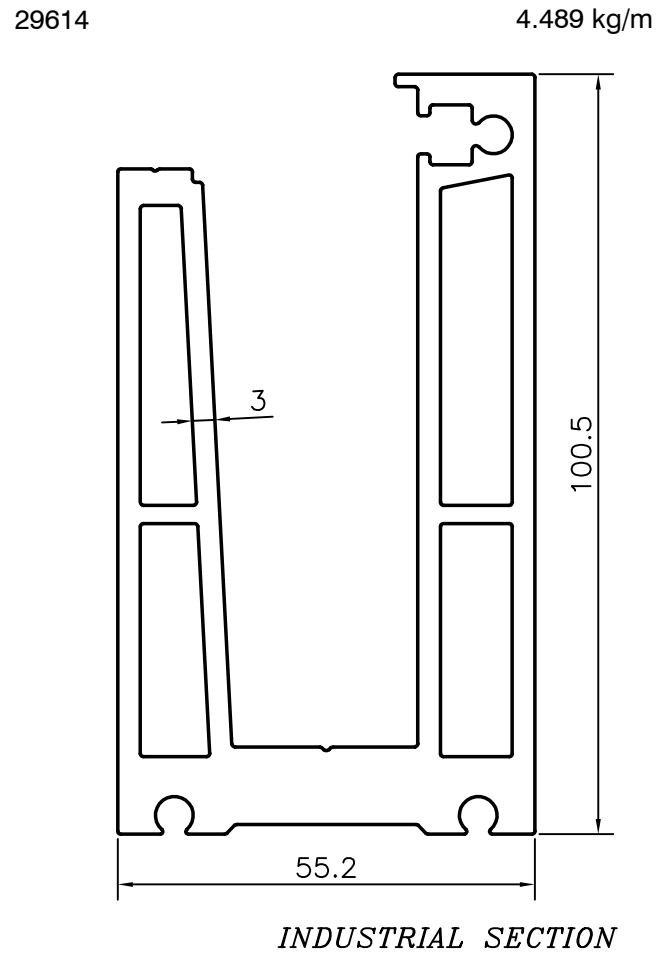
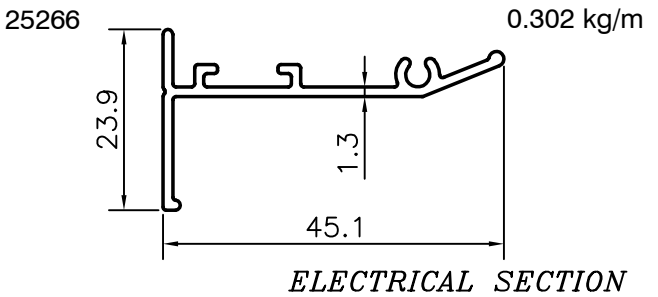
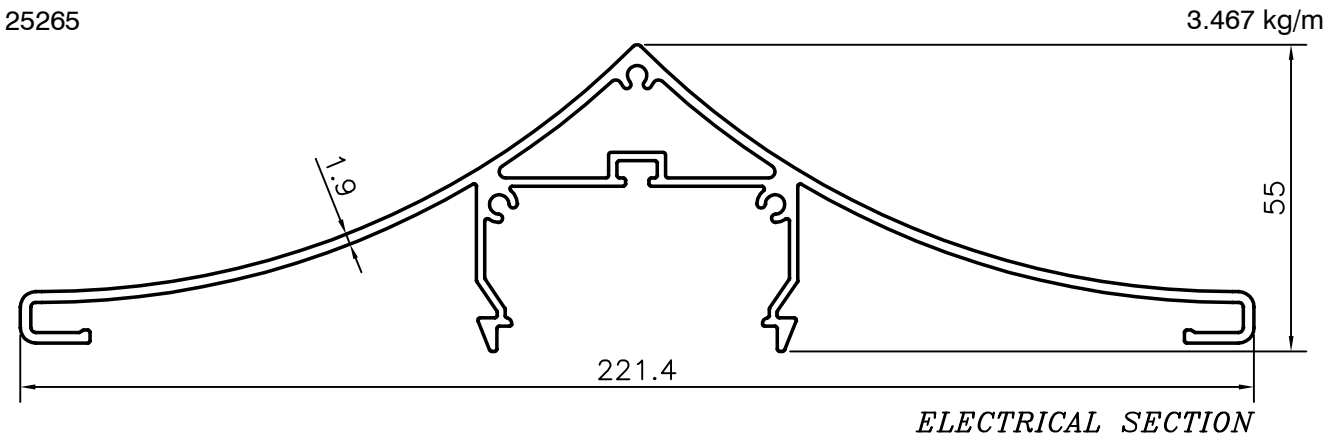
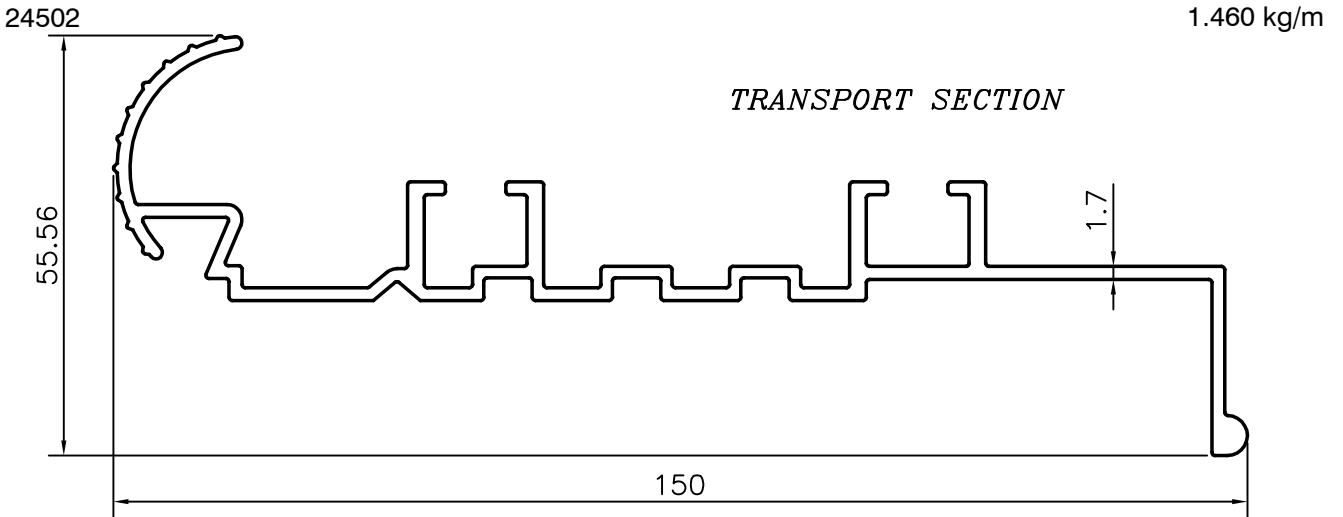



33556

0.759 kg/m

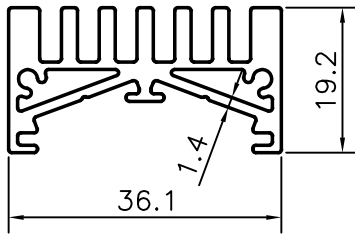

HEAT SINK SECTION

S4815

7.699 kg/m

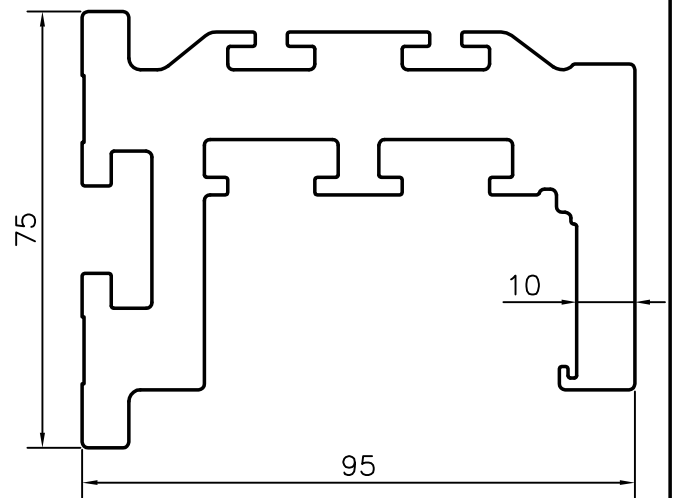

INDUSTRIAL SECTION

S4816

0.470 kg/m

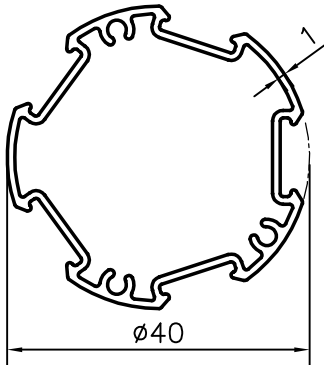

ELECTRICAL SECTION

S4817

1.839 kg/m

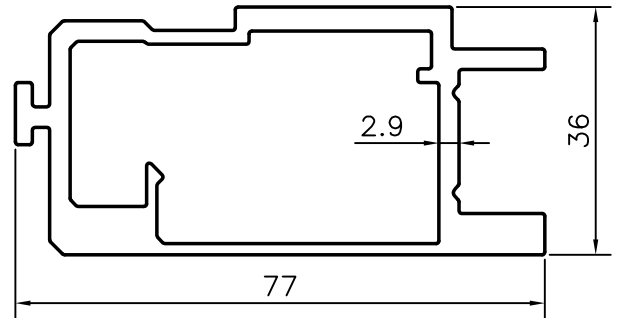

TEXTILE SECTION

S4818

0.277 kg/m

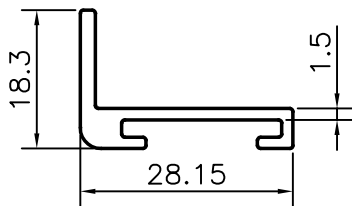

INDUSTRIAL SECTION

S4819

0.294 kg/m

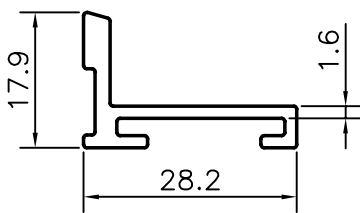

INDUSTRIAL SECTION

S4820

0.438 kg/m

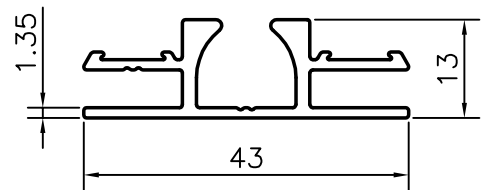

INDUSTRIAL SECTION

S4821

1.671 kg/m

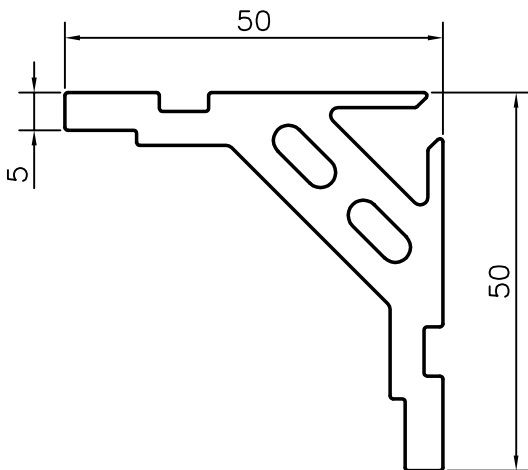

INDUSTRIAL SECTION

S4822

7.830 kg/m

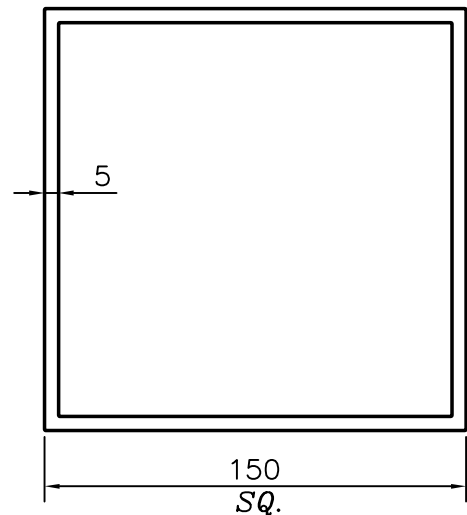

SQUARE TUBE



S4823

0.723 kg/m

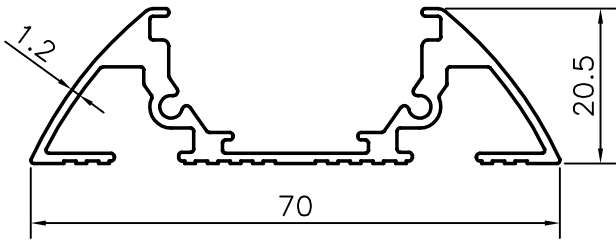

ELECTRICAL SECTION

S4825

3.113 kg/m

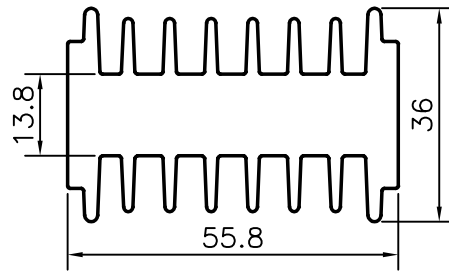

HEAT SINK SECTION

S4824

6.774 kg/m

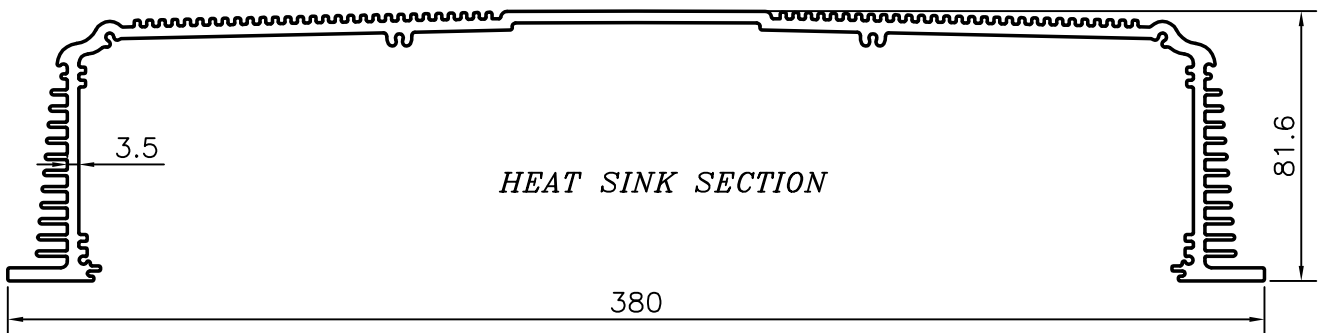

HEAT SINK SECTION

S4827

0.056 kg/m

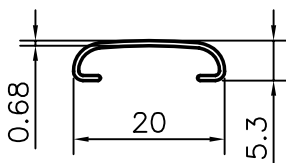

BEADING SECTION

S4828

0.064 kg/m

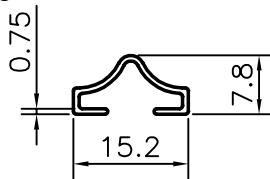

BEADING SECTION

S4829

0.062 kg/m

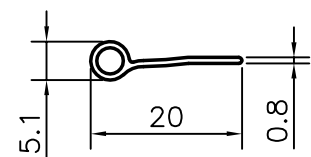

BEADING SECTION

S4830

23.850 kg/m

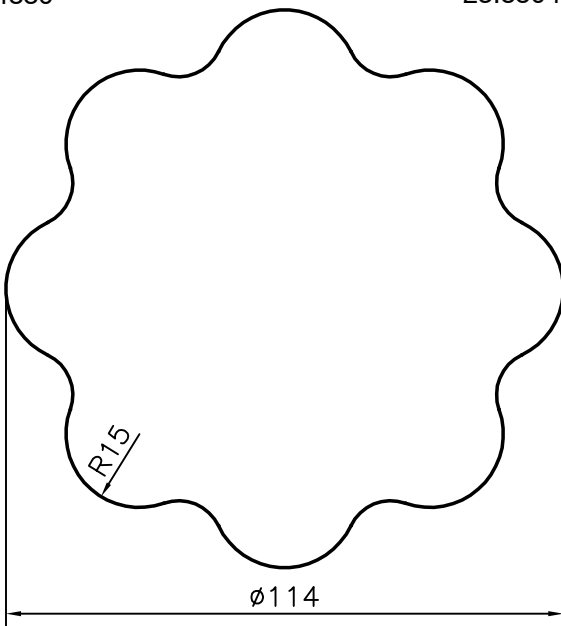

INDUSTRIAL SECTION

S4832

0.316 kg/m

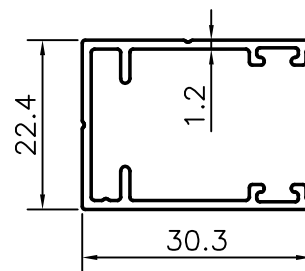

VENETIAN BLIND SECTION

S4835

0.166 kg/m

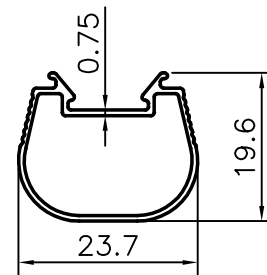

TUBE LIGHT SECTION