

BULBED TEES & TOP HATS

BULBED TEES - TAPERED HEAD

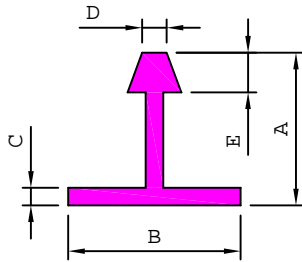

SL. No.	Section No.	A	B	C	D	E	Weight kg/m
1	17304	36.50	25.00	1.10	2.80	2.80	0.195
2	17302	36.50	25.00	1.60	2.80	2.80	0.270

TOP HATS

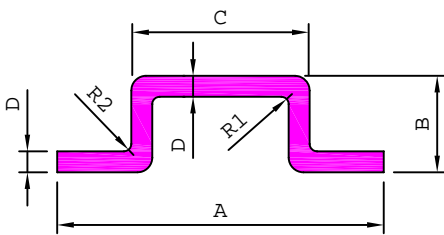

SL. No.	Section No.	A	B	C	D	R1	R2	Weight kg/m
1	17457	31.15	12.70	12.00	3.18	--	--	0.430
2	17459	34.00	7.15	12.50	1.20	--	--	0.148
3	17456	40.00	16.00	20.00	4.00	--	--	0.690
4	17452	57.15	28.50	23.81	2.39	0.50	0.50	0.706
5	17453	63.50	31.75	25.40	3.18	-	1.60	1.038
6	17455	88.90	44.45	44.45	3.18	3.18	3.18	1.495

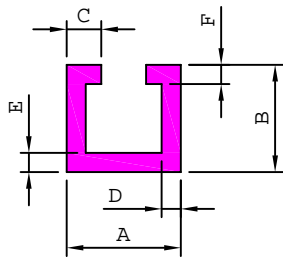

SL. No.	Section No.	A	B	C	D	E	F	Weight kg/m
1	17696	14.10	21.10	4.90	2.80	2.80	2.80	0.415
2	17634	24.00	24.00	7.50	1.25	1.25	1.25	0.276

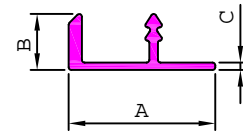
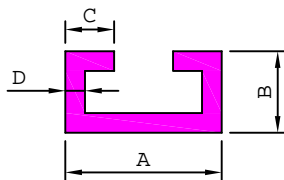

SL. No.	Section No.	A	B	C	Weight kg/m
1	16699	22.00	8.40	1.10	0.132
2	17698	24.00	8.40	1.10	0.138

SL. No.	Section No.	A	B	C	D	Weight kg/m
1	17527	20.00	11.00	5.50	0.60	0.082
2	17506	20.84	11.70	5.92	1.00	0.140
3	17509	20.84	11.70	5.92	1.25	0.172
4	17512	20.84	11.70	5.92	1.62	0.216
5	17523	21.50	11.00	6.25	2.00	0.259
6	17522	22.00	10.00	4.00	1.00	0.124
7	17503	22.00	14.00	6.50	1.25	0.195
8	17570	22.50	14.00	6.75	1.00	0.163
9	17504	22.50	14.00	6.75	2.50	0.364
10	17651	32.00	18.00	8.25	3.00	0.587
11	17518	35.00	18.00	10.50	4.00	0.820
12	17640	160.00	70.00	30.00	3.00	2.818

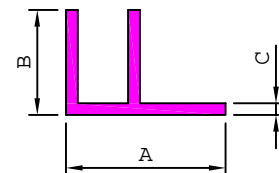

SL. No.	Section No.	A	B	C	Weight kg/m
1	17544	21.30	16.00	1.35	0.184
2	17710	23.40	15.30	0.67	0.095
3	17555	23.40	15.30	0.97	0.136
4	17602	23.40	15.30	1.40	0.193
5	17697	25.00	16.00	1.30	0.191

MISCELLANEOUS

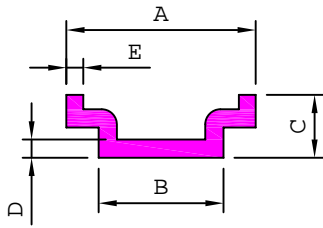

SL. No.	Section No.	A	B	C	D	E	Weight kg/m
1	17580	23.50	15.20	7.80	1.25	1.05	0.108
2	17558	24.50	15.80	7.80	1.55	1.10	0.126
3	17559	24.50	15.80	7.80	2.00	1.20	0.148

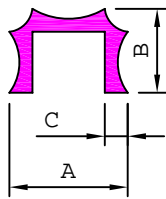

SL. No.	Section No.	A	B	C	Weight kg/m
1	17508	15.60	11.30	2.65	0.175
2	17542	15.50	11.00	2.90	0.130
3	17543	15.00	11.00	2.60	0.165

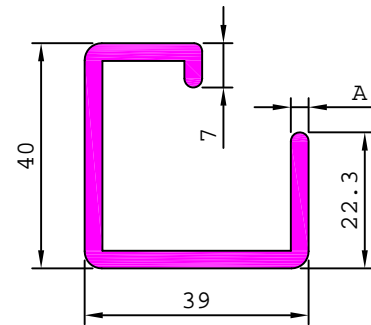

SL. No.	Section No.	A	Weight kg/m
1	17528	2.65	0.828
2	17532	1.95	0.621

17502

0.036 kg/m

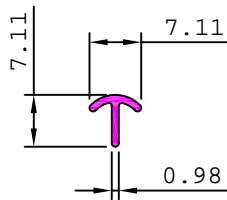

17511

0.151 kg/m

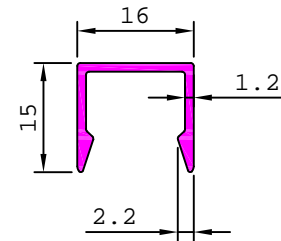

17514

0.053 kg/m

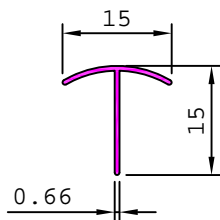

17515

0.283 kg/m

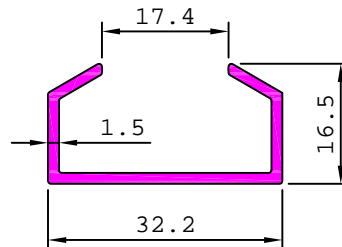

17517

0.175 kg/m

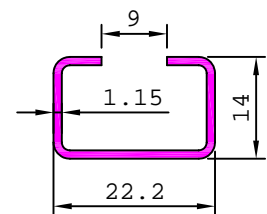

17519

0.364 kg/m

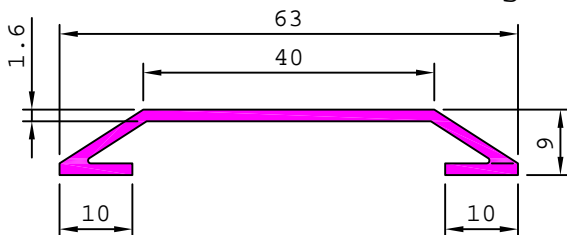

17520

0.190 kg/m

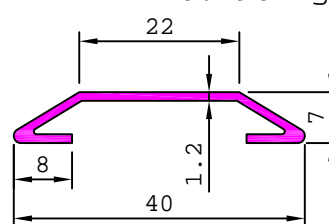

17521

0.137 kg/m

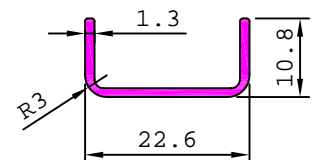

MISCELLANEOUS

17524 0.109 kg/m

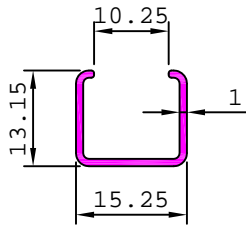

17529 0.891 kg/m

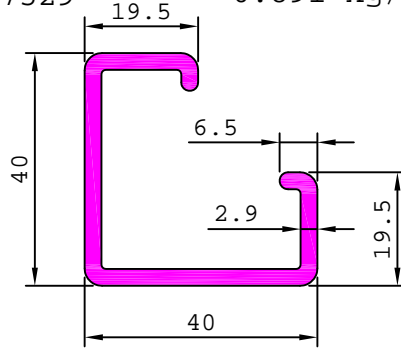

17533 0.133 kg/m

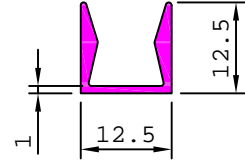

17537 0.742 kg/m

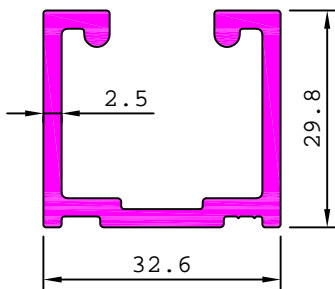

17538 0.381 kg/m

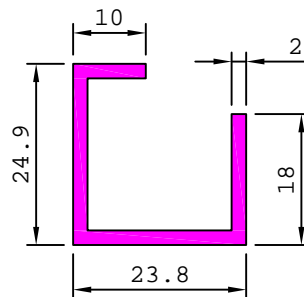

17539 0.268 kg/m

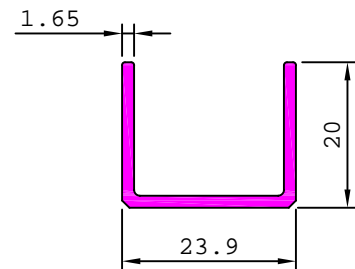

17541 0.231 kg/m

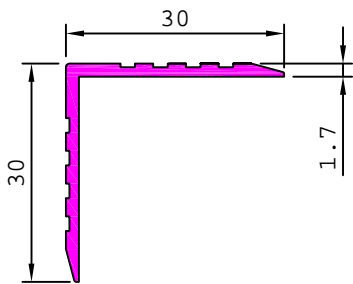

17545 0.184 kg/m

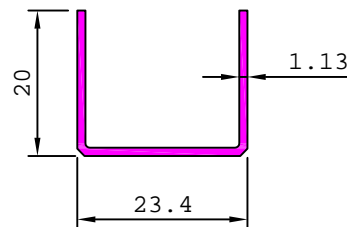

17546 1.000 kg/m

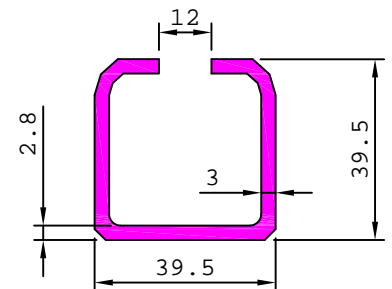

17547 0.673 kg/m

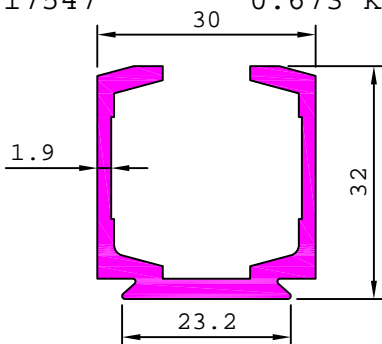

17549 0.360 kg/m

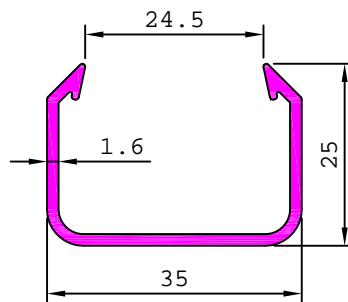

17550 0.720 kg/m

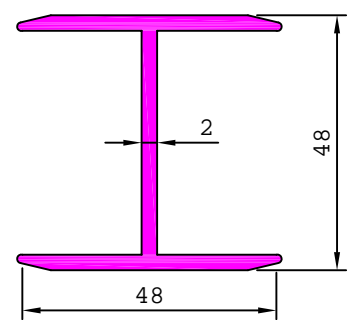

17551 0.628 kg/m

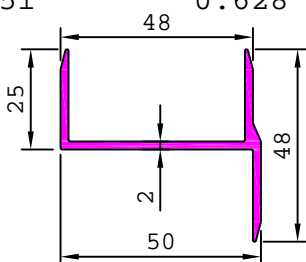

17552 0.538 kg/m

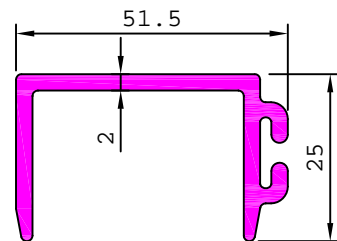

17553 0.209 kg/m

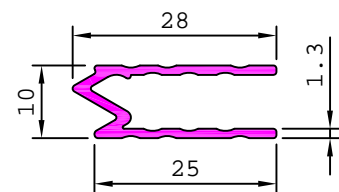

MISCELLANEOUS

17554 0.309 kg/m

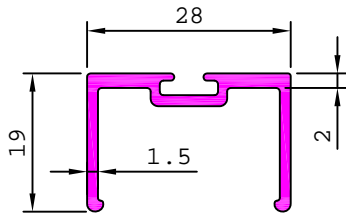

17556 0.628 kg/m

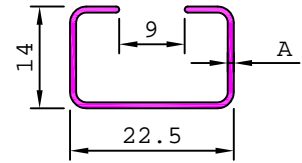
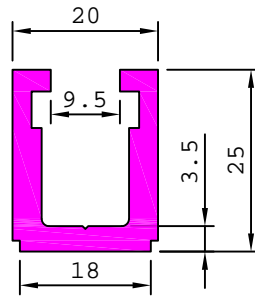

SL. No.	Section No.	A	Weight kg/m
1	17647	0.70	0.109
2	17557	0.83	0.128

17564 0.385 kg/m

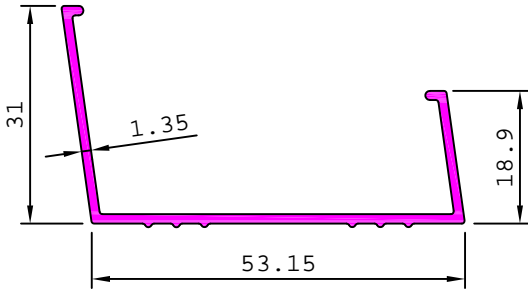

17565 0.389 kg/m

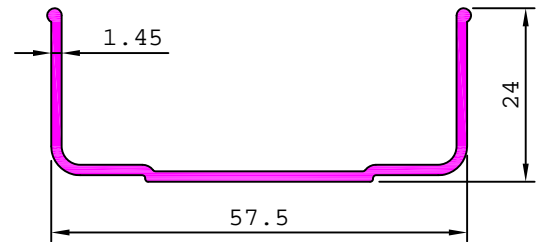

17566 0.190 kg/m

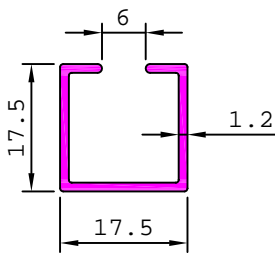

17572 0.657 kg/m

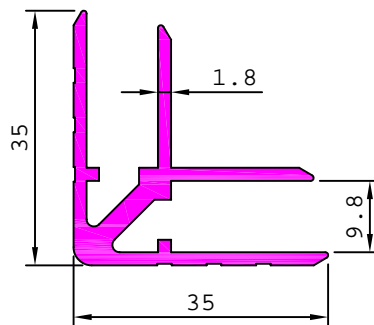

17573 0.300 kg/m

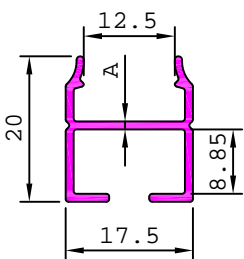
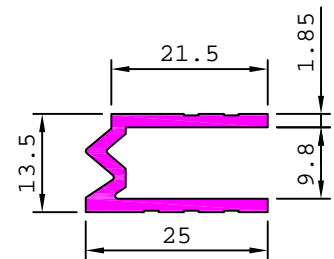

SL. No.	Section No.	A	Weight kg/m
1	17638	0.70	0.134
2	17594	0.81	0.150
3	17569	1.10	0.195

17574 0.203 kg/m

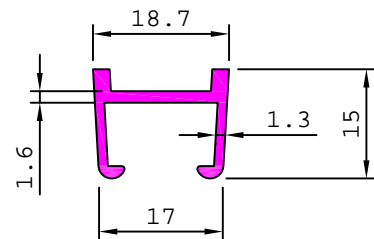

17576 0.193 kg/m

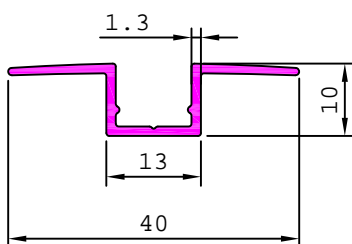

17579 0.123 kg/m

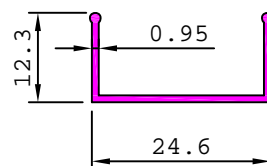

17581 0.244 kg/m

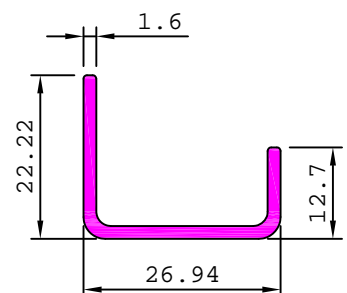

MISCELLANEOUS

17582 0.885 kg/m

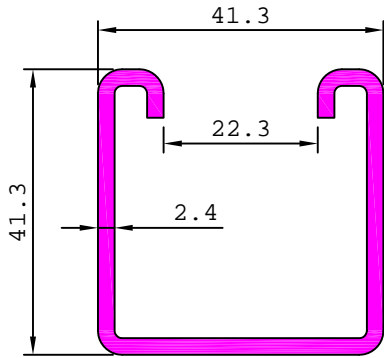

17584 0.640 kg/m

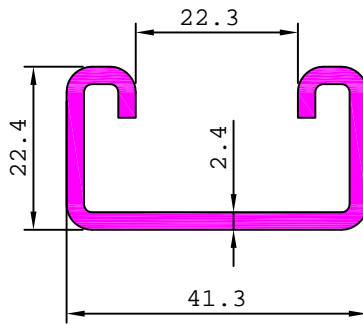

17585 0.226 kg/m

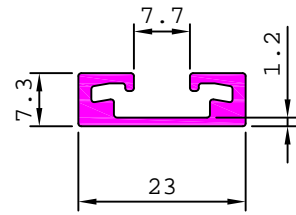

17586 0.523 kg/m

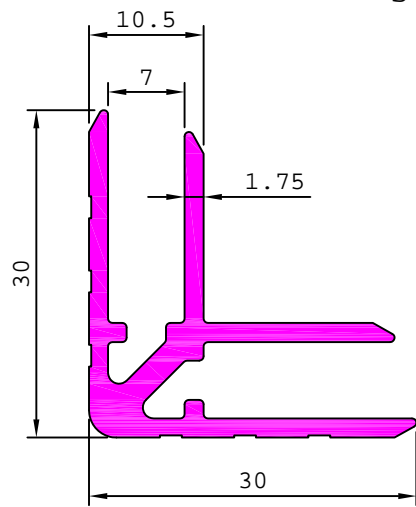

17587 1.147 kg/m

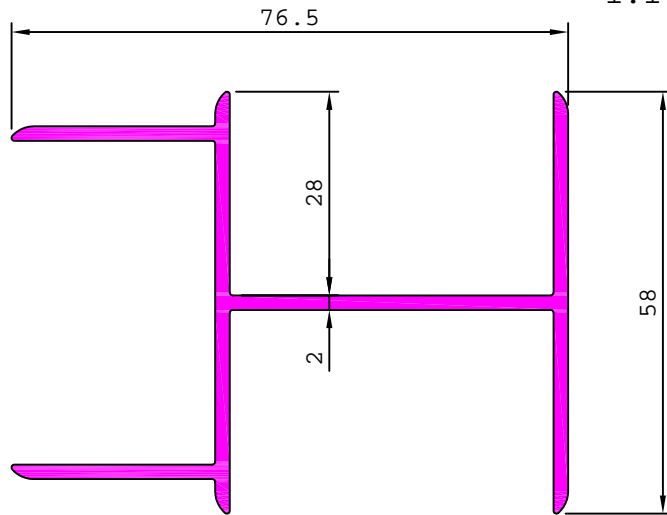

17588 0.605 kg/m

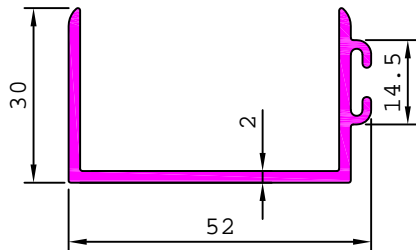

17590 0.584 kg/m

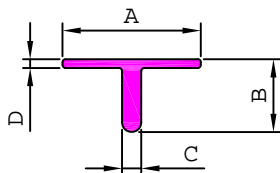
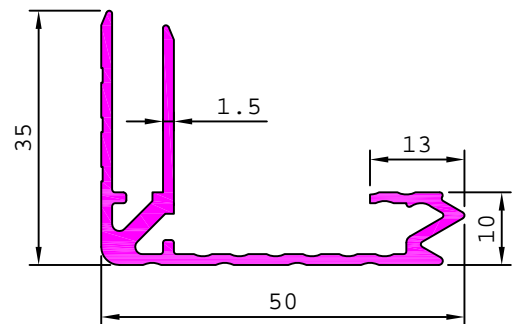

SL. No.	Section No.	A	B	C	D	Weight kg/m
1	17629	10.00	6.60	3.00	1.50	0.079
2	17626	12.90	6.60	3.00	1.50	0.091
3	17593	13.00	8.00	2.65	1.20	0.088
4	17627	15.90	7.80	3.00	1.40	0.109
5	17591	15.90	8.00	2.75	1.20	0.099
6	17592	19.00	10.00	2.65	1.20	0.122

17597 1.853 kg/m

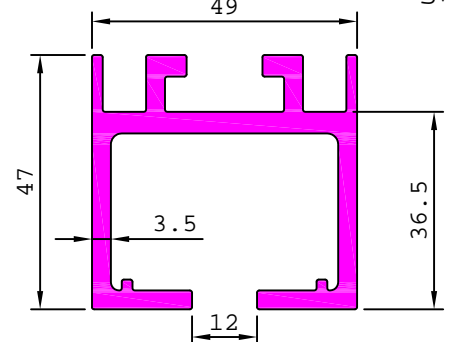

MISCELLANEOUS

17595 0.118 kg/m

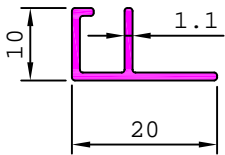

17601 0.112 kg/m

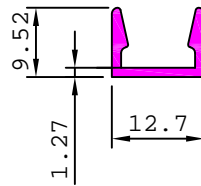

17603 0.249 kg/m

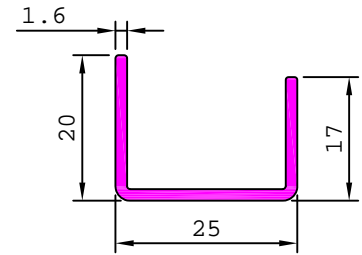

17604 0.204 kg/m

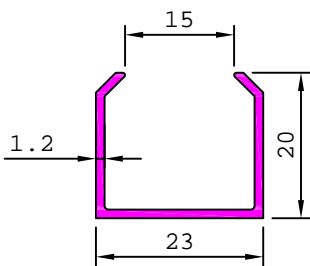

17605 0.310 kg/m

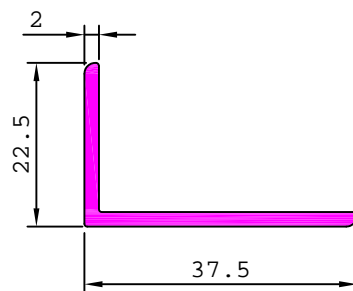

17606 0.348 kg/m

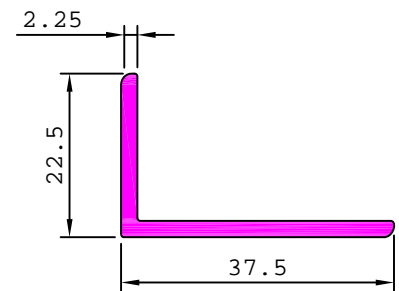

17607 0.432 kg/m

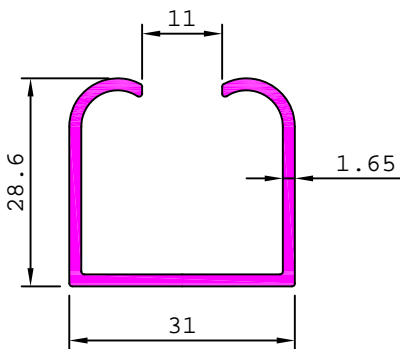

17608 0.288 kg/m

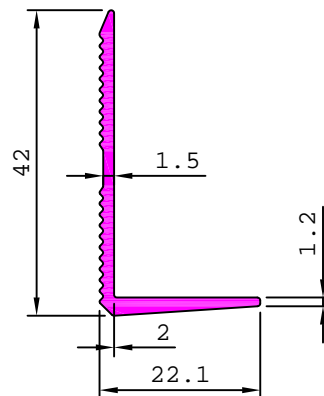

17609 0.561 kg/m

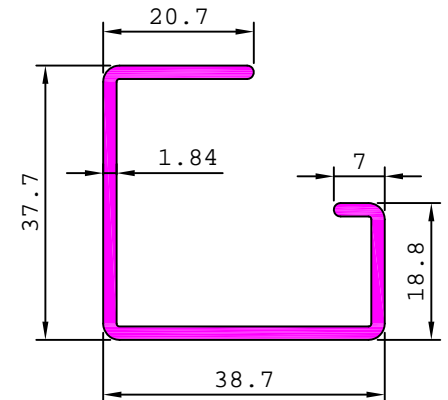

17610 0.186 kg/m

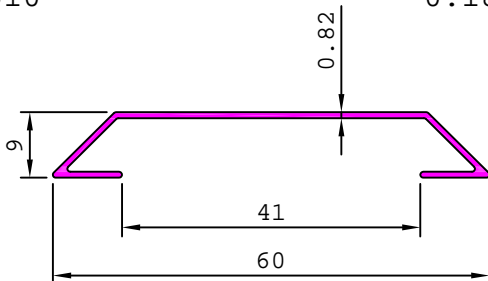

17611 0.741 kg/m

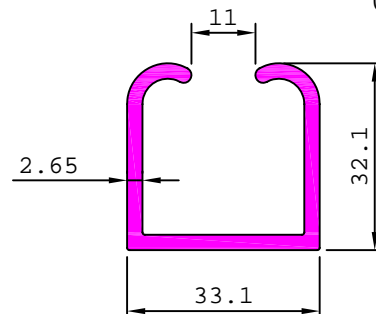

17612 0.146 kg/m

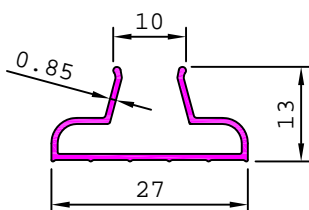

17613 0.499 kg/m

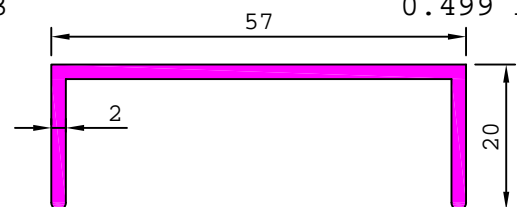

MISCELLANEOUS

17614 0.162 kg/m

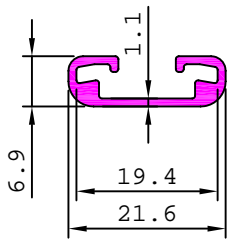

17615 0.597 kg/m

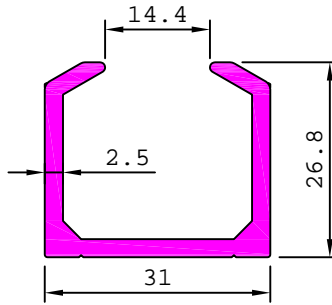

17616 0.301 kg/m

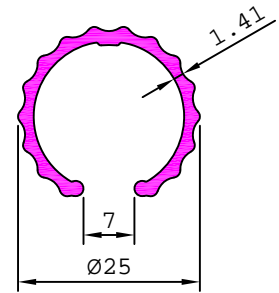

17617 0.112 kg/m

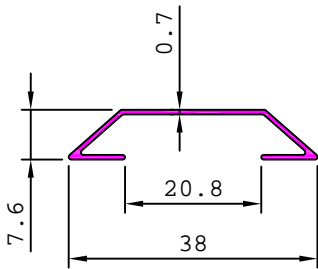

17618 0.762 kg/m

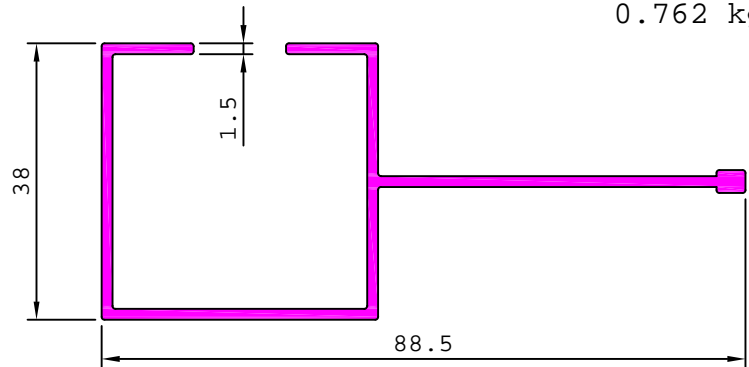

17619 0.331 kg/m

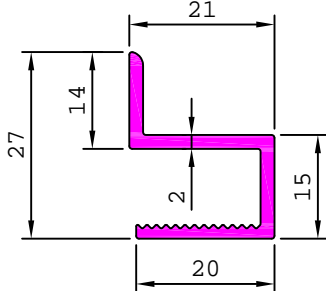

17621 0.200 kg/m

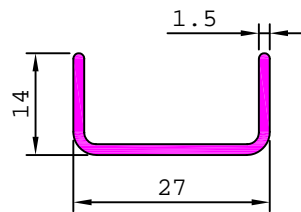

17622 0.092 kg/m

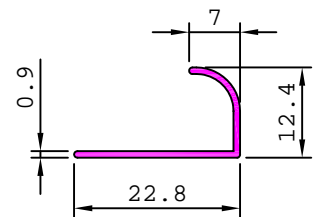

17624 0.137 kg/m

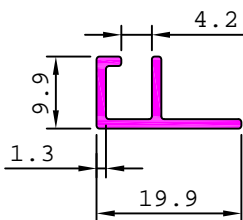

17625 0.096 kg/m

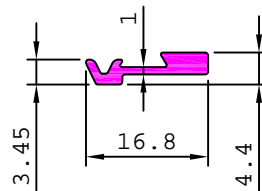

17630 0.632 kg/m

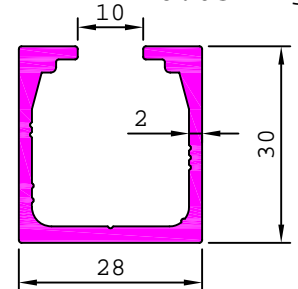

17635 0.123 kg/m

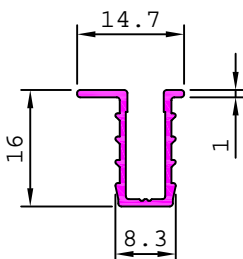

17642 0.169 kg/m

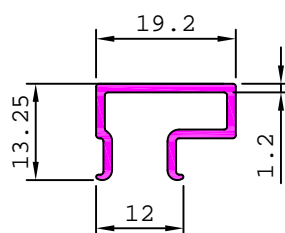

17644 0.218 kg/m

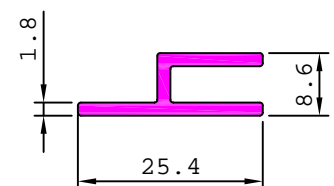

MISCELLANEOUS

17641

1.190 kg/m

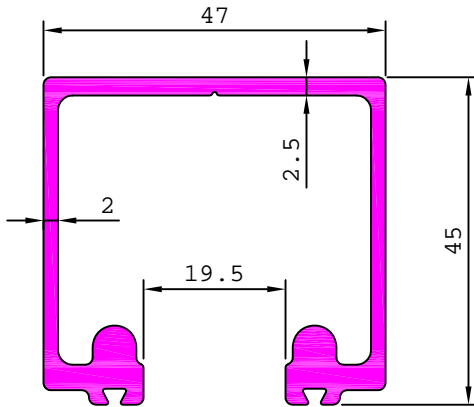

17643

4.172 kg/m

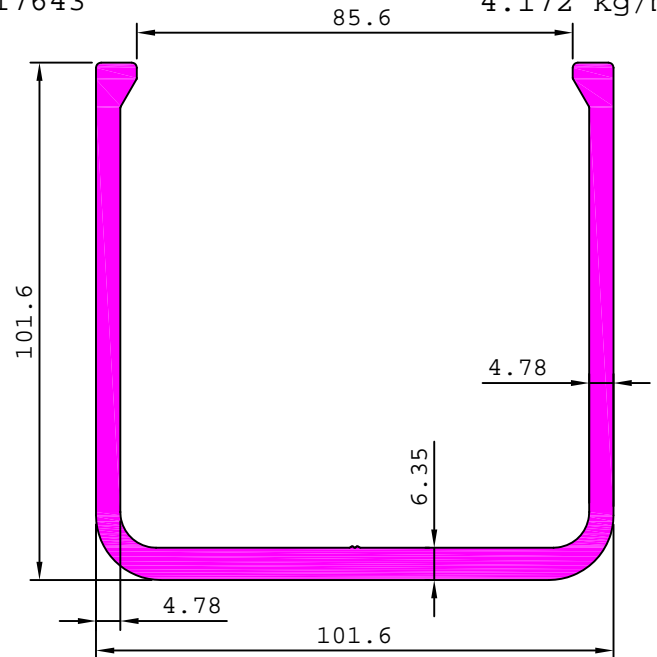

17645

0.084 kg/m

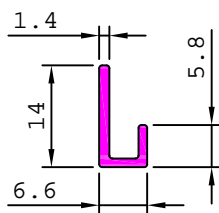

17646

0.071 kg/m

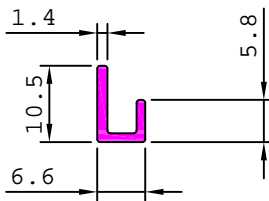

17648

0.221 kg/m

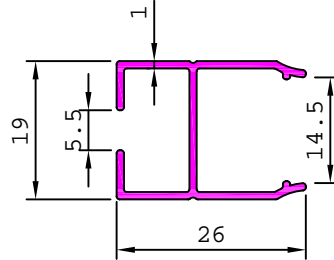

17650

0.499 kg/m

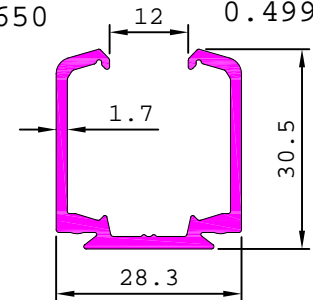

17652

1.540 kg/m

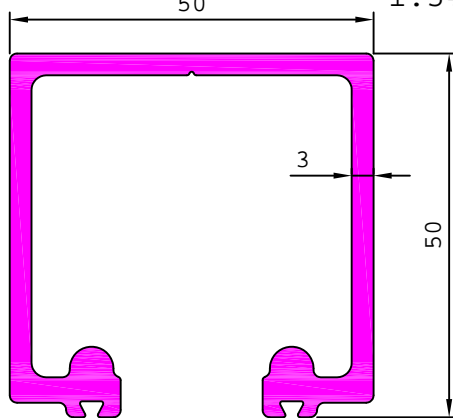

17654

1.435 kg/m

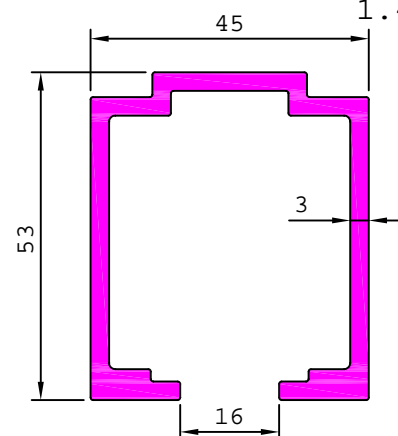

17656

1.761 kg/m

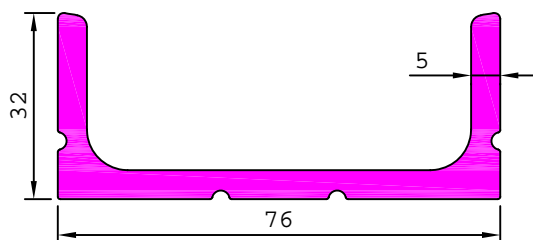

17657

0.509 kg/m

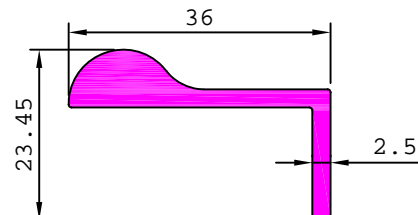

MISCELLANEOUS

17655

4.275 kg/m

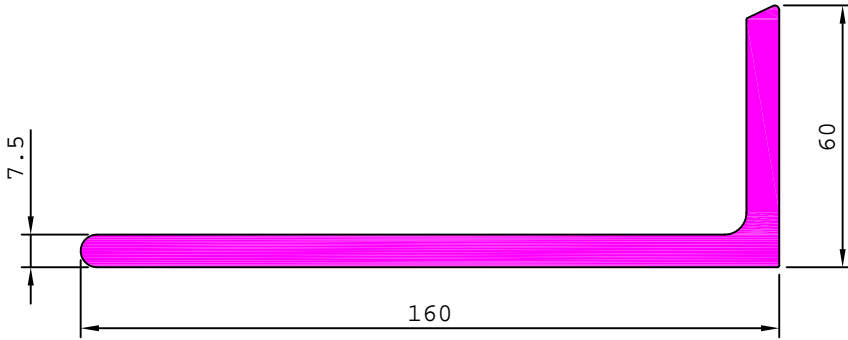

17658

0.495 kg/m

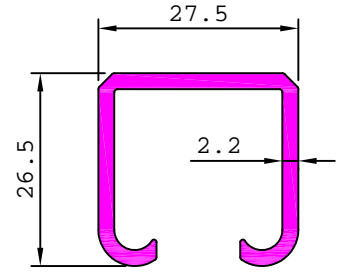

17659

0.207 kg/m

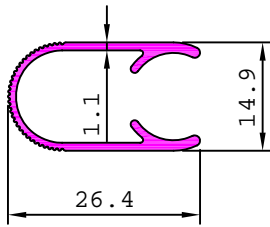

17660

0.222 kg/m

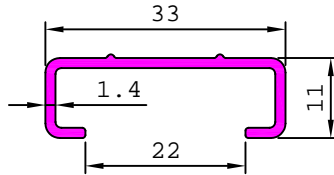

17662

0.953 kg/m

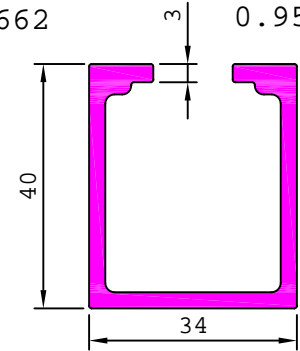

17661

0.702 kg/m

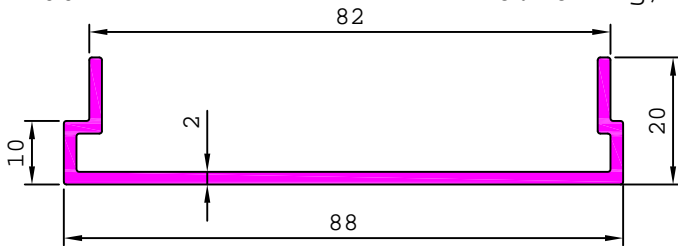

17664

0.248 kg/m

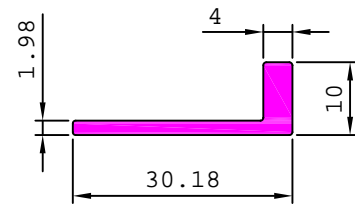

17665

0.133 kg/m

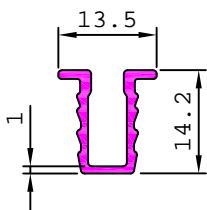

17666

0.245 kg/m

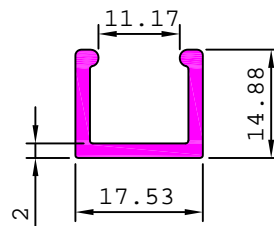

17667

0.090 kg/m

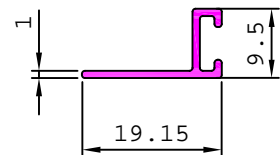

17668

0.237 kg/m

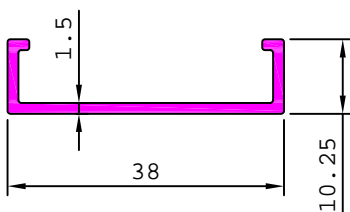

17669

0.108 kg/m

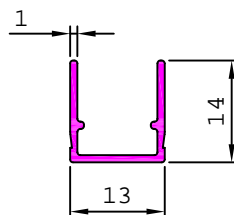

17670

0.852 kg/m

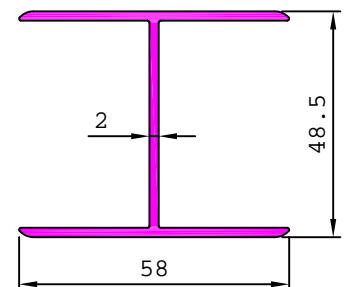

MISCELLANEOUS

17671 0.712 kg/m

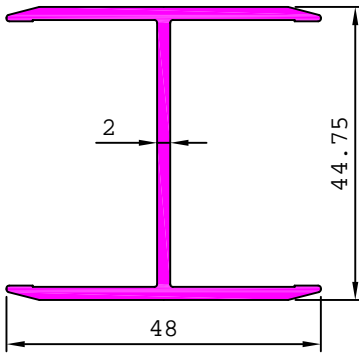

17672 0.618 kg/m

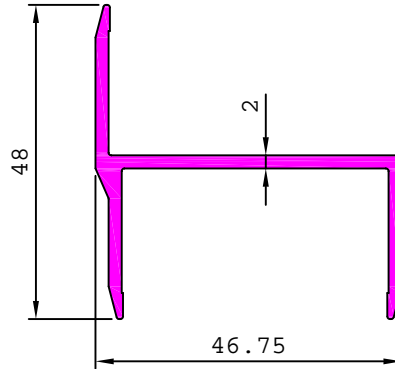

17673 0.525 kg/m

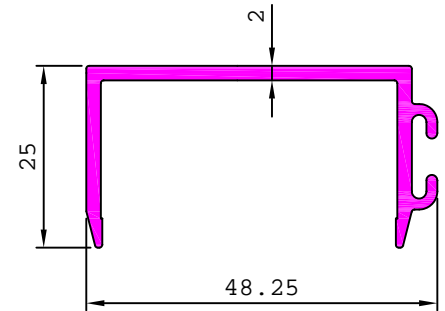

17675 0.237 kg/m

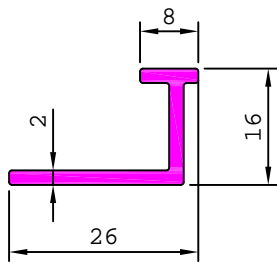

17676 0.619 kg/m

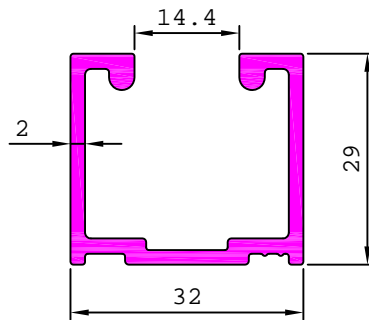

17677 1.038 kg/m

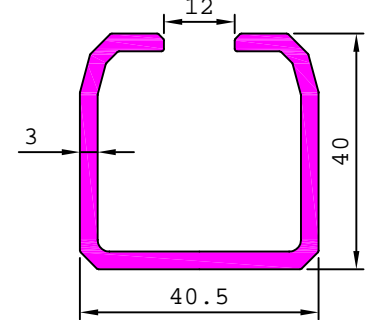

17678 0.241 kg/m

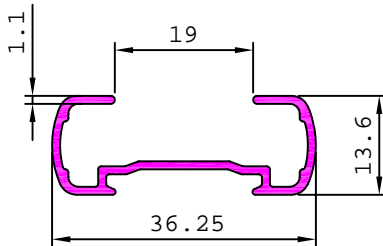

17680 0.108 kg/m

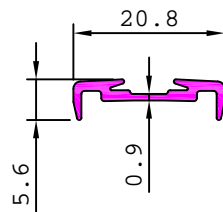

17681 0.114 kg/m

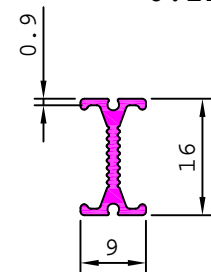

17679 0.618 kg/m

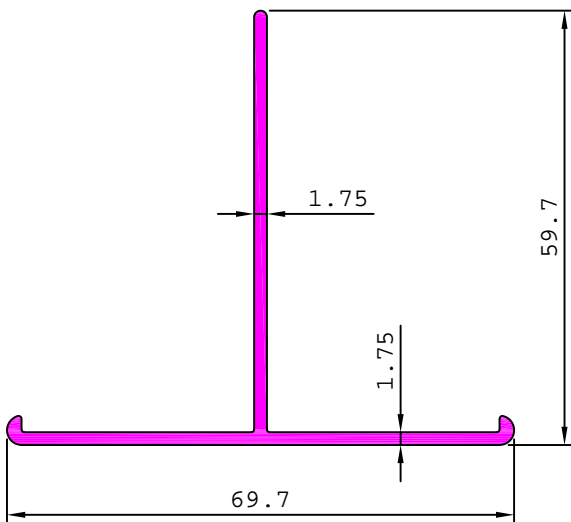

17682 1.483 kg/m

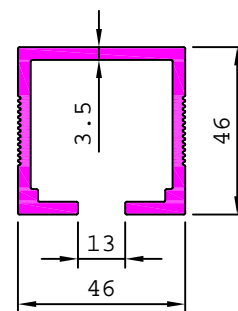

17683 0.801 kg/m

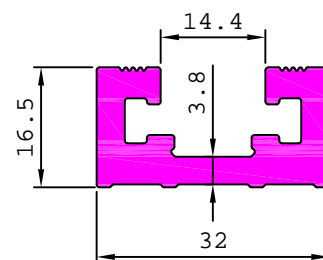

MISCELLANEOUS

17684

0.155 kg/m

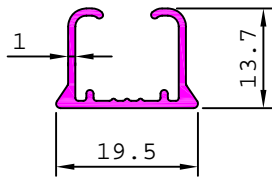

17685

0.184 kg/m

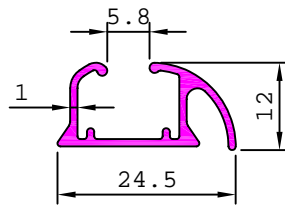

17686

1.261 kg/m

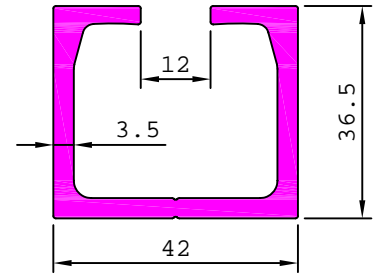

17688

2.142 kg/m

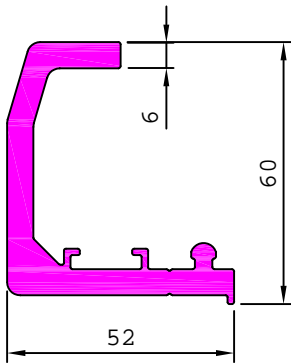

17689

1.890 kg/m

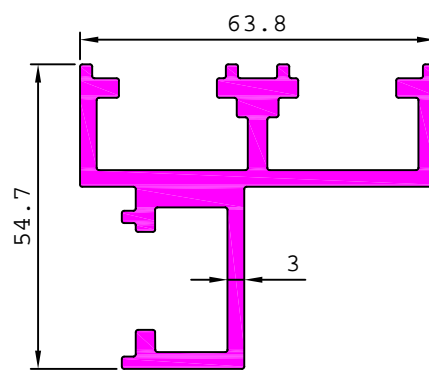

17690

1.820 kg/m

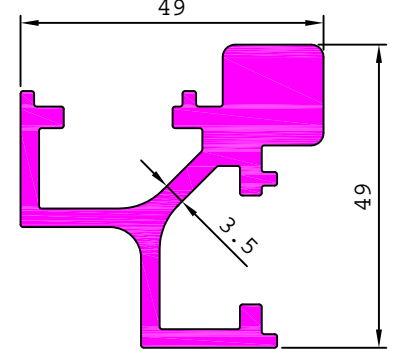

17691

2.243 kg/m

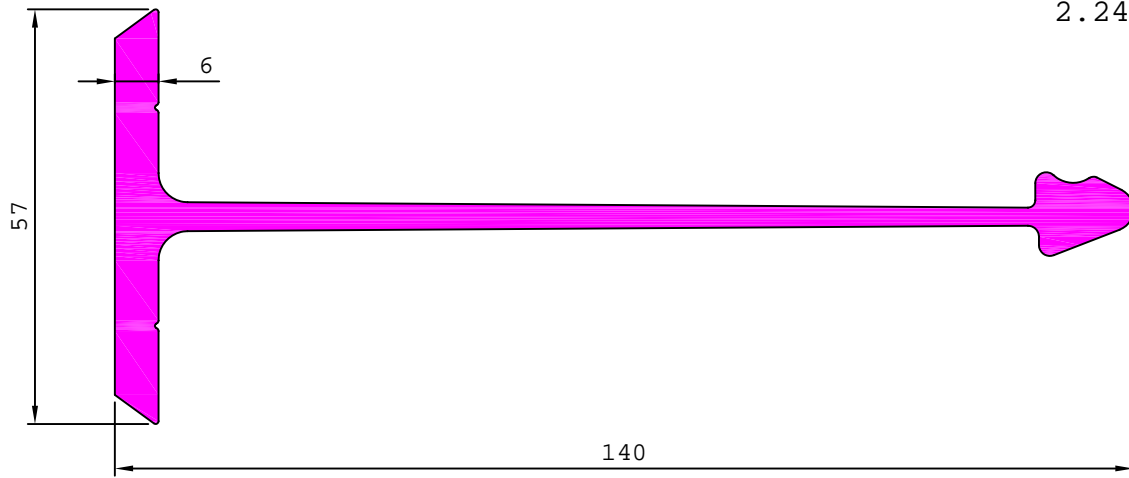

17692

2.024 kg/m

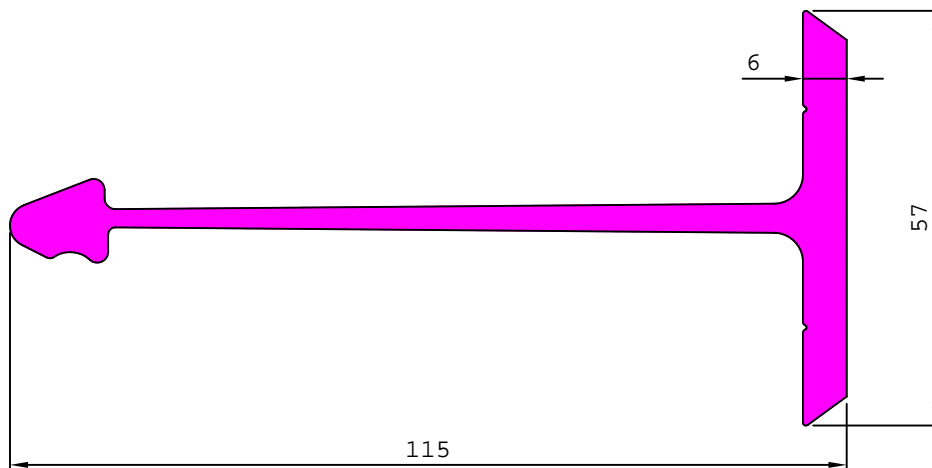

MISCELLANEOUS

17693 0.124 kg/m

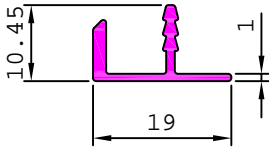

17700 0.136 kg/m

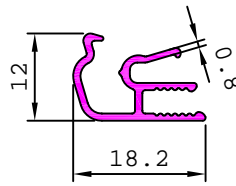

17701 0.041 kg/m

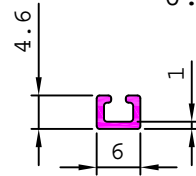

17694 0.736 kg/m

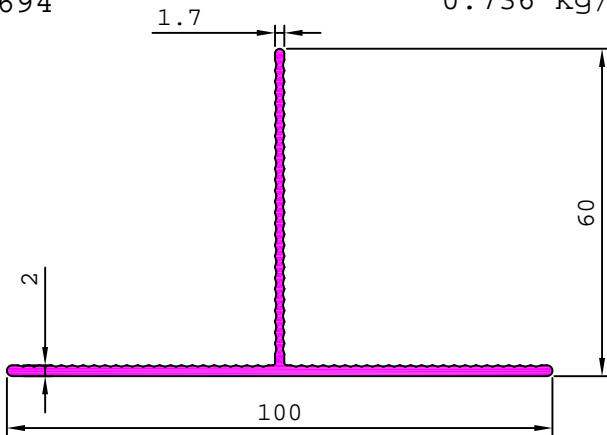

17695 0.481 kg/m

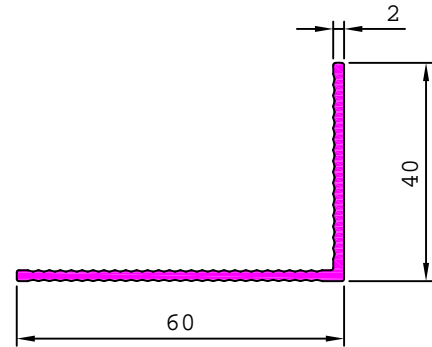

17702 0.415 kg/m

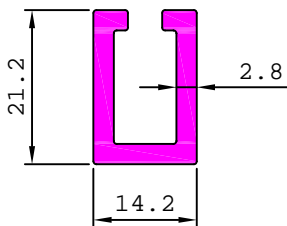

17703 0.151 kg/m

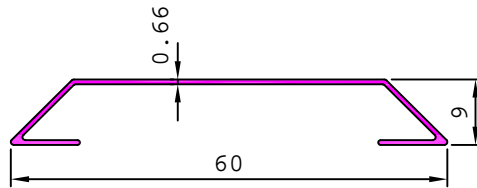

17704 0.115 kg/m

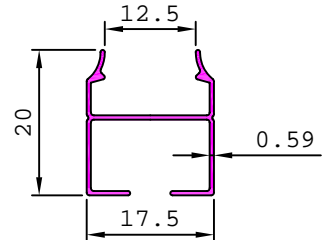

17705 0.200 kg/m

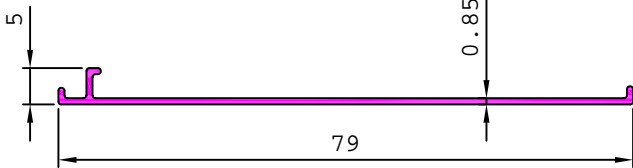

17706 0.078 kg/m

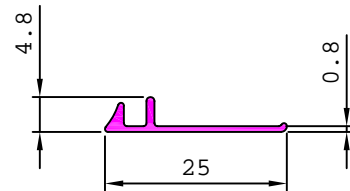

17707 1.223 kg/m

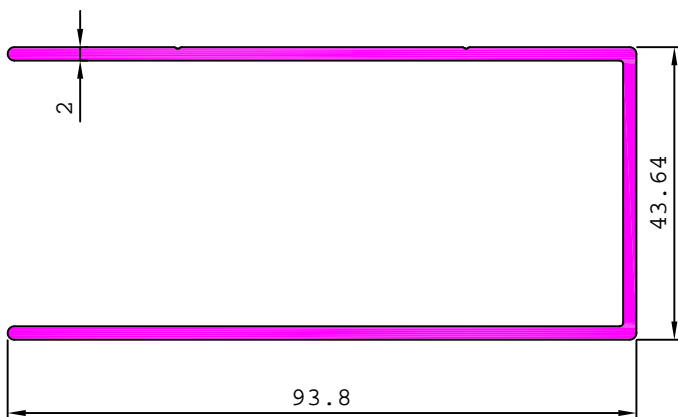

17708 0.188 kg/m

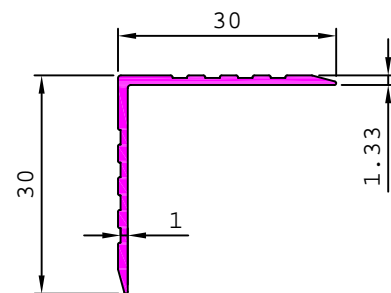

MISCELLANEOUS

17709

0.104 kg/m

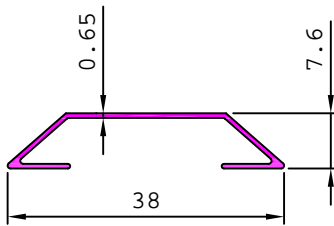

17711

0.096 kg/m

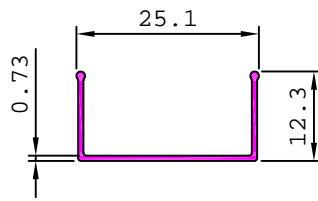

17712

0.652 kg/m

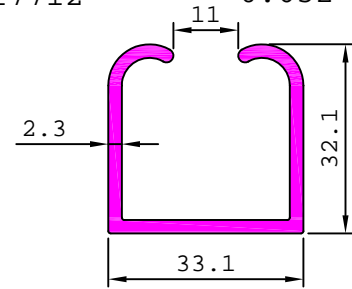

17713

0.325 kg/m

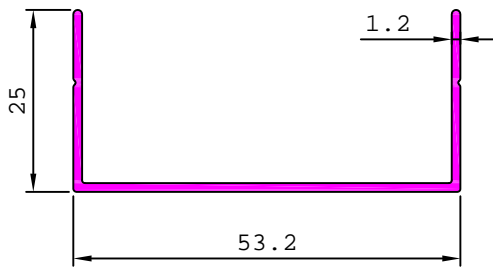

17714

0.648 kg/m

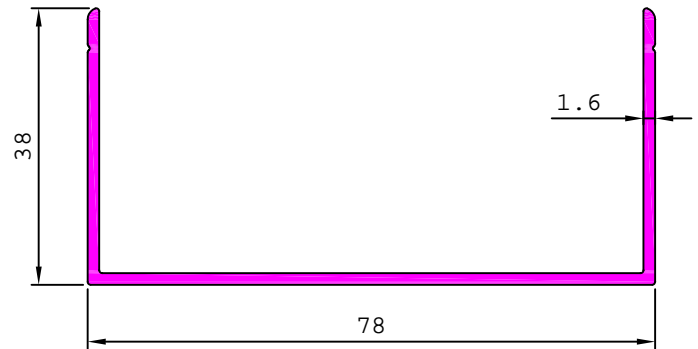

29308

0.112 kg/m

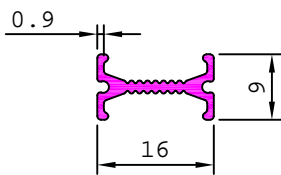

29364

0.099 kg/m

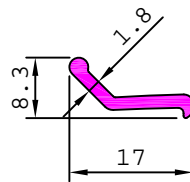

29365

0.185 kg/m

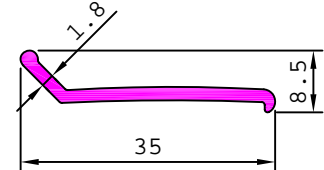

29366

0.317 kg/m

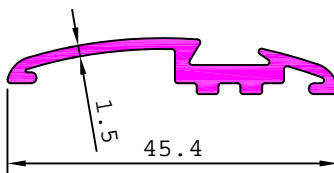

29378

0.420 kg/m

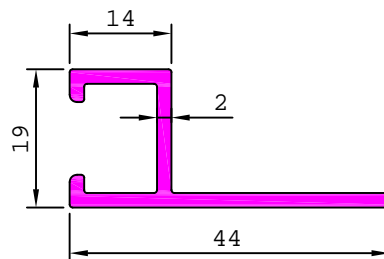

29379

0.105 kg/m

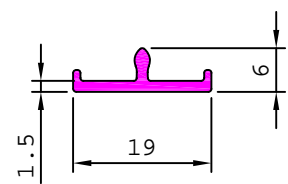

29381

0.953 kg/m

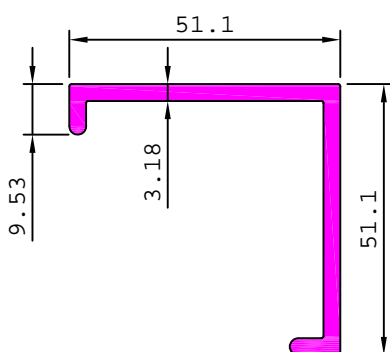

29436

0.081 kg/m

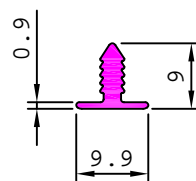

34509

0.190 kg/m

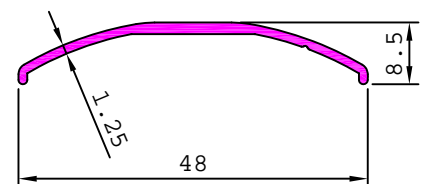

MISCELLANEOUS

34510

0.232 kg/m

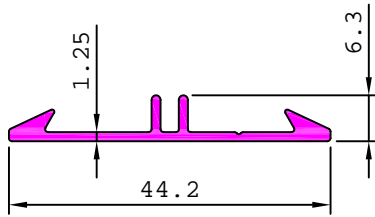

27884

1.543 kg/m

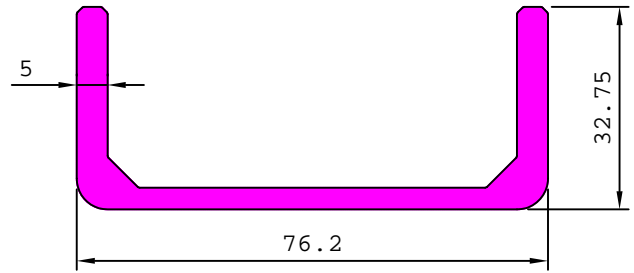

29517

0.128 kg/m

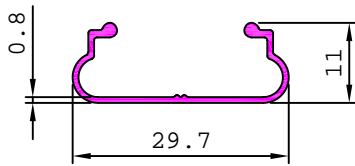

34557

0.120 kg/m

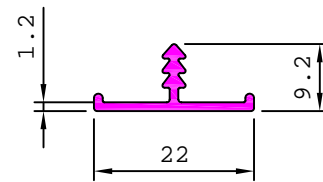

S3245

0.820 kg/m

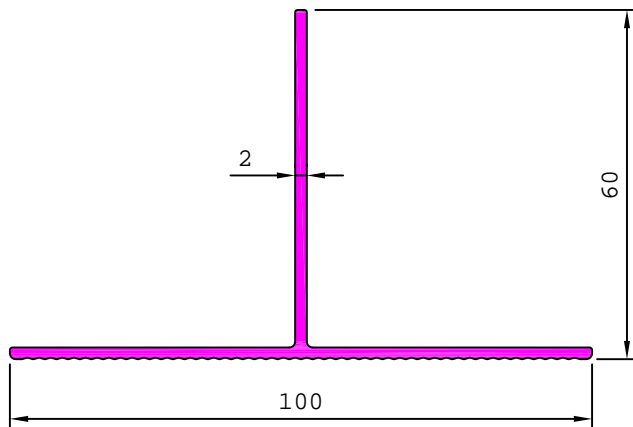

S3741

0.935 kg/m

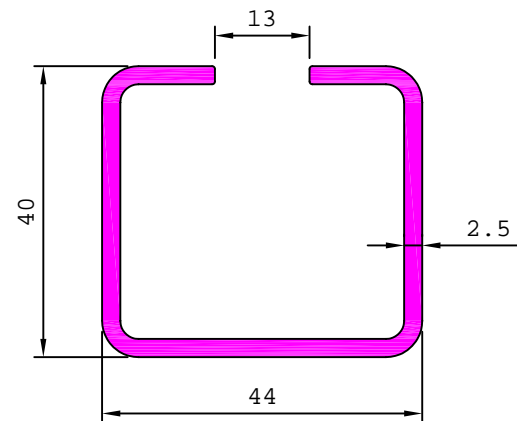

S3630

16.537 kg/m

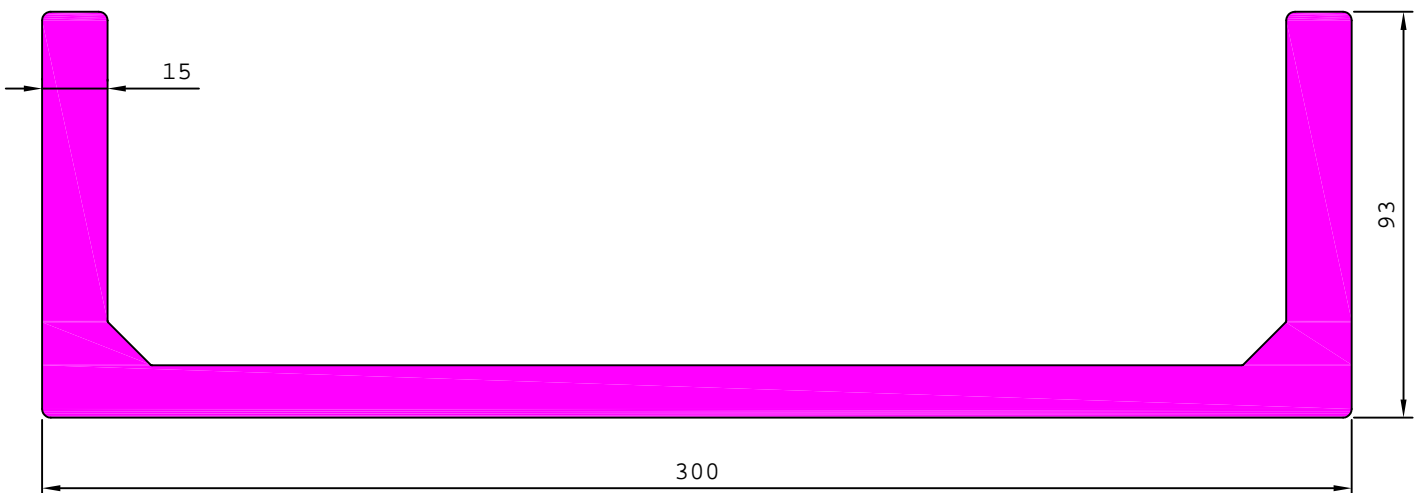

MISCELLANEOUS

S4070

0.267 kg/m

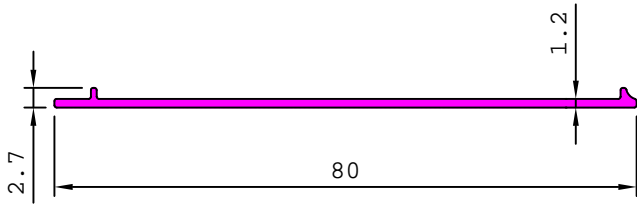

S4161

2.546 kg/m

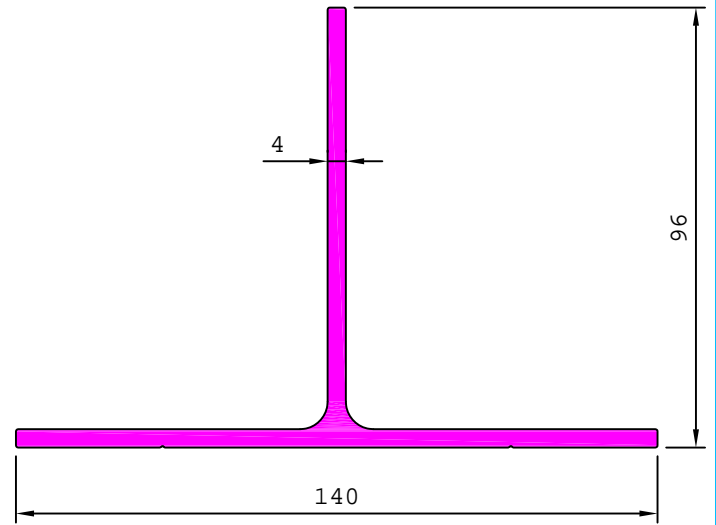

S4071

0.270 kg/m

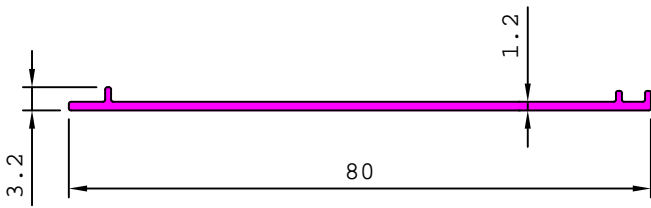

27828

1.397 kg/m

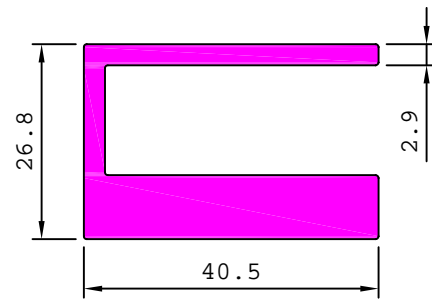

22936

0.395 kg/m

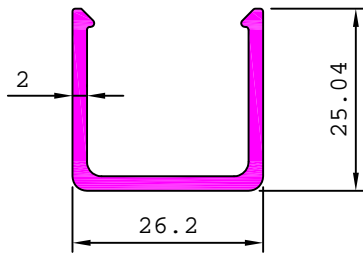

28048

0.499 kg/m

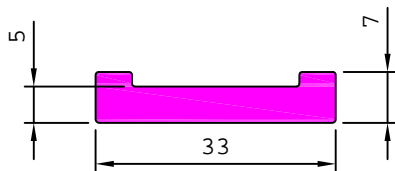

S4115

0.188 kg/m

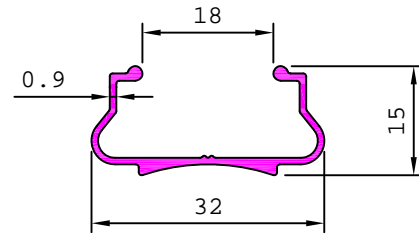

29376

0.168 kg/m

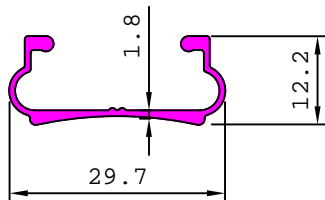

29377

0.274 kg/m

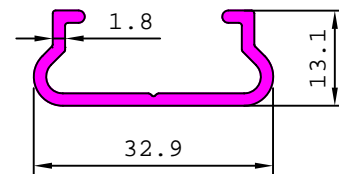

29509

0.137 kg/m

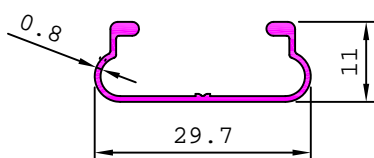

29539

1.632 kg/m

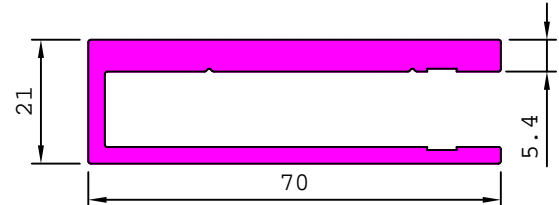

MISCELLANEOUS

29547

0.301 kg/m

